

Revision			
Rev.	Description	Date	Approved
A-2		2016/07/18	R/D

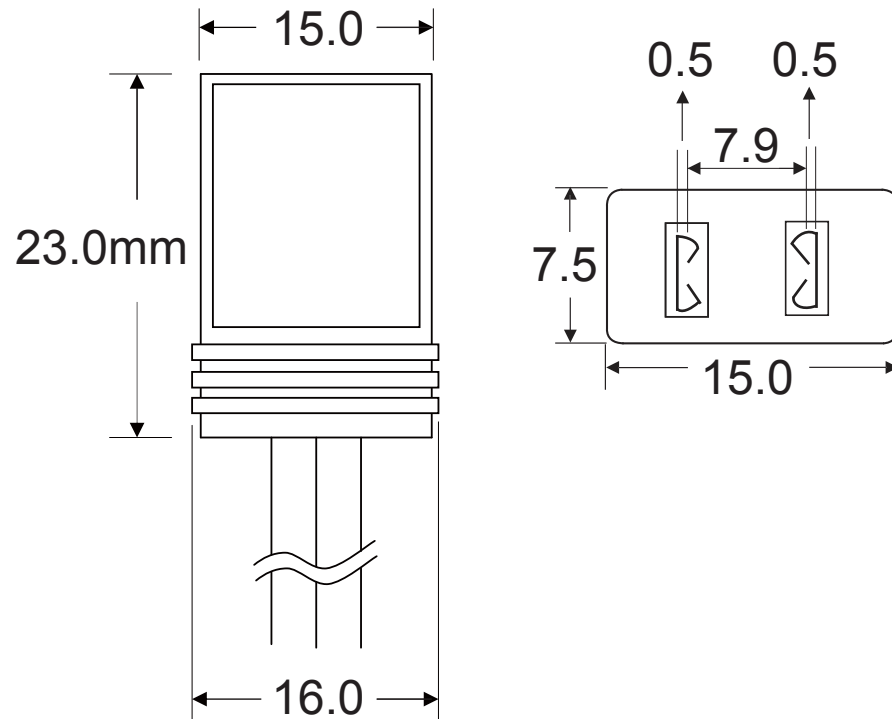

Description:

Model No. Information:

- C180-05-XX (XX=cord length, Meter or Feet)
- Fit tib size: 3.1W. X Thk.0.5mm for C180-05
- Material: PVC compound UL94V-0

Plug:

- Contact: brass for C180-05
- Fit tib size: 3.1W. X Thk.0.5mm for C180-05
- Material: PVC compound UL94V-0

Cord:

- UL/CSA listed spt-1 18awg x 2c 105° black
- Any length buyer's need is acceptable upon request
- Ending: cut off or stripped / tinned are optional



Sinwan Electric Industries Co., Ltd.

Part Number:

C180-05

Description:

Fan Power Cord
For 0.5mm push-in terminal pins